

# NACM SERIES STANDARD DAMPER ACTUATOR

Modulating Control  
5 Nm

## NACM...05 SERIES

NACM standard damper actuators are specially designed and produced for applications in the HVAC Systems. Our wide range of Nenutec standard damper actuators has been developed to operate and position air dampers of different sizes.



## PRODUCT FEATURE

- Torque 5 Nm
- Damper size 1.0 m<sup>2</sup>
- Power supply AC/DC 24V
- Modulating Control Signal DC 0(2)...10 V
- Shaft dimensions - Ø 6...15 mm / □ 5...10.5 mm
- Minimum Shaft Length 40 mm
- Adjustable angle of rotation
- Selectable direction of rotation of reversing actuator
- Actuator with 1 m cable connection
- Manual Over-ride push button when required

## MODEL SELECTION TABLE

MODEL / TYPE	TORQUE	POWER SUPPLY	RUNNING TIME	AUXILIARY SWITCH
NACM 1.2-05	5 Nm	AC/DC 24 V ± 10%	60...90 sec	-

## DIMENSION (mm)

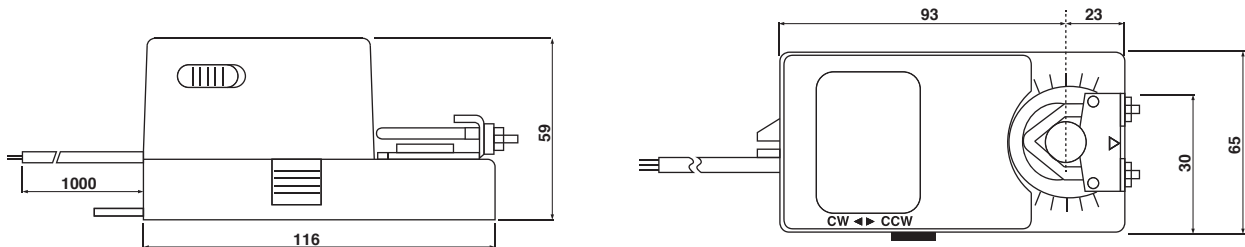

## TECHNICAL SPECIFICATION

<b>MODEL NUMBER</b>	<b>NACM 1.2-05</b>
<b>TORQUE</b>	5 Nm
<b>DAMPER SIZE</b>	1.0 m <sup>2</sup>
<b>SHAFT DIMENSION</b>	Ø 6...15 mm / □ 5...10.5 mm
<b>POWER SUPPLY</b>	AC/DC 24 V ± 10%
<b>FREQUENCY</b>	50...60 Hz
<b>CONTROL SIGNAL (INPUT)</b>	DC 0(2)...10 V
<b>POSITION SIGNAL (OUTPUT)</b>	DC 0...10 V
<b>POWER CONSUMPTION</b>	
● OPERATING	4.0 W
● END POSITION	2.0 W
<b>FOR WIRE SIZING</b>	14.0 VA
<b>ELECTRICAL CONNECTION</b>	1 m Cable
<b>PROTECTION CLASS</b>	Class III ⚡
<b>ANGLE OF ROTATION</b>	90° (95° mechanical)
<b>WEIGHT</b>	< 0.7 Kg
<b>LIFE CYCLE</b>	60,000 Rotation
<b>SOUND LEVEL</b>	40 dB
<b>IP PROTECTION</b>	IP54
<b>OPERATING TEMPERATURE</b>	-20°...50° as per IEC 721-3-3
<b>NON-OPERATING TEMPERATURE</b>	-30°...+60° C / IEC 721-3-2
<b>AMBIENT HUMIDITY</b>	5%...95% rH non condensing / EN
<b>MAINTENANCE</b>	Maintenance Free
<b>MODE OF OPERATION</b>	Type I / EN 60730-1
<b>EMC</b>	CE & ISO 9000 EN / EEC

# NACM SERIES STANDARD DAMPER ACTUATOR

Modulating Control  
5 Nm

## WIRING DIAGRAM NACM...05 POWER SUPPLY AC/DC 24V

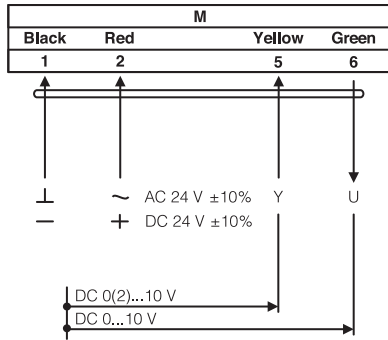

## DIRECTION OF ROTATION NACM...05

Default factory setting: CW.

Direction of rotation can be change by toggling between CW/CCW switch on the actuator's housing.

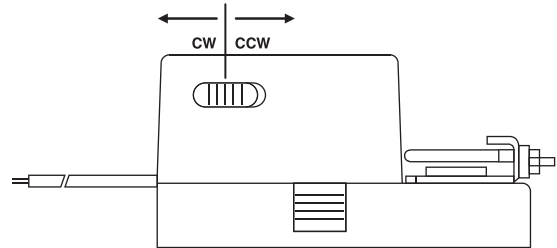

## WIRING DIAGRAM NACM...05 PARALLEL CONNECTION

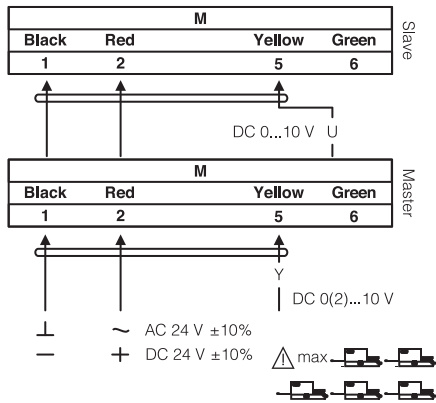

## REMARK

During parallel operation, the output signal (terminal 6, DC 0...10 V) of the master actuator must be connected to terminal 5 of the next slave actuator.

## RELEASING THE ADAPTER NACM...05

Releasing the adapter is not required.

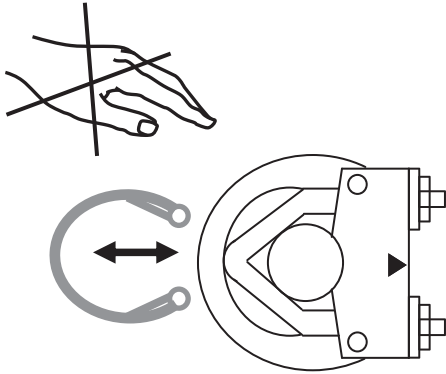

## LIMITING ANGLE OF ROTATION NACM...05

Adjustment of Mechanical Limiter

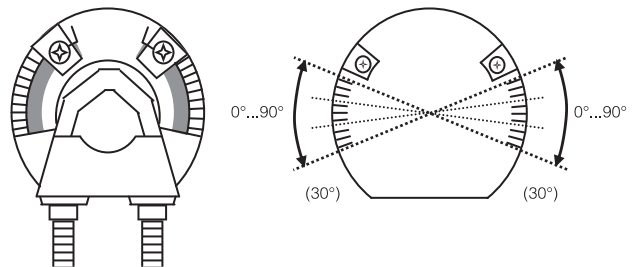

1. Loosen screw of mechanical limiter
2. Move limiter to appropriate position\*
3. Tighten screw

\*Working range of 90° can be reduced up to 30° from end position.



## IMPORTANT REMARK

For special requirement, consult your local Nenuotec's representative.

  This actuator includes electrical and electronic components and may not be disposed as household garbage. Please consider the local valid legislation.

 AC / DC 24 V: Connect via safety isolating transformer.  
AC 230 V: To isolate from the main power supply, the system must incorporate a device which disconnects the phase conductor (with at least a 3mm contact gap.)

The performance specifications are nominal and conform to acceptable industry standards. Nenuotec shall not be liable for damages resulting from misapplication or misuse of its products.